

Microwave Oven

user manual

imagine the possibilities

Thank you for purchasing a Samsung product. To receive a more complete service, please register your product at

www.samsung.com/global/register

SAMSUNG

features

Professional Design

Samsung New OTR with Stainless Steel, it has professional look and the design matches great with other kitchen appliances, so that it provides harmonious kitchen interior and finally completes total kitchen solution.

Turbo vent

With 400CFM ventilation power, New OTR can keep the comfortable cooking condition by absorbing smoke and odor from cook-top. Moreover, it provides the silent condition that is equivalent noise level to other OTR with lower ventilation power.

The Strongest power without additional noise! That's the benefit you can feel from New OTR!

Big Interior capacity for convenience

With the 1.8 cu.ft capacity, it offers enough space to cook. The big capacity combined with 1,100 watts of output achieves superior cooking results.

Sensor cook











Don't worry about failure of your cooking! New OTR's sensor technology offers the best dish. Only thing you need to do is just select the cooking menu, and then you will be satisfied with the cooking results by sensor cook.

VFD display

With more informative VFD display, the OTR helps you use all the function it has with ease.

safety information

WHAT THE ICONS AND SIGNS IN THIS MANUAL MEAN:

	WARNING: Hazards or unsafe practices that may result in severe personal injury or death.
	CAUTION: Hazards or unsafe practices that may result in minor personal injury or property damage.
	Do not attempt or use.
	Do not repair.
	Do not touch.
	Be careful
	Follow directions explicitly.
	Unplug the power plug from the wall socket.
	Make sure the machine is grounded to prevent electric shock.
	Call the service center for help.
	Note

PRECAUTIONS TO AVOID POSSIBLE EXPOSURE TO EXCESSIVE MICROWAVE ENERGY:

-  Do not attempt to operate this oven with the door open since open-door operation can result in harmful exposure to microwave energy. It is important not to defeat or tamper with the safety interlocks.

Do not place any object between the oven front face and the door or allow soil or cleaner residue to accumulate on sealing surfaces.

Do not operate the oven if it is damaged. It is particularly important that the oven door close properly and that there is no damage to the

- Door (bent or dented),
- Hinges and latches (broken or loosened),
- Door seals and sealing surfaces.

-  The oven should not be adjusted or repaired by anyone except properly qualified service personnel.

SAVE THESE INSTRUCTIONS

IMPORTANT SAFETY INSTRUCTIONS

When using any electrical appliance, basic safety precautions should be followed, including the following:

WARNING

-  Always observe Safety Precautions when using your oven. Never try to repair the oven on your own - there is dangerous voltage inside. If the oven needs to be repaired, call 1-800-SAMSUNG (7267864) for the name of an authorized service center near you.

TO REDUCE RISK OF BURNS, ELECTRIC SHOCK, FIRE, PERSONAL INJURY OR EXPOSURE TO EXCESSIVE MICROWAVE ENERGY:

-  Read all safety instructions before using the appliance.

Read and follow the specific **“PRECAUTIONS TO AVOID EXPOSURE TO EXCESSIVE MICROWAVE ENERGY”** on page 3.

This appliance must be grounded. Connect only to properly grounded outlets. See **“IMPORTANT GROUNDING INSTRUCTIONS”** on page 7 of this manual.

Install or place this appliance only in accordance with the installation instructions provided.

Use this appliance only for its intended use as described in the manual. Do not use corrosive chemicals or vapors in this appliance. This type of oven is specifically designed to heat, cook, or dry food. It is not designed for industrial or laboratory use.

As with any appliance, close supervision is necessary when used by children.

Keep the inside of the oven clean. Food particles or spattered oils stuck to the oven walls or floor can cause paint damage and reduce the efficiency of the oven.

Keep cord away from heated surfaces.

When cleaning door and oven surfaces, use only mild, nonabrasive soaps or detergents applied with a sponge or soft cloth.

Remove lids from baby food before heating. After heating baby food, stir well and test temperature by tasting before serving.

This over-the-range oven was designed for use over ranges no wider than 91.44 cm(36 inches). It may be installed over both gas and electric cooking equipment.

SAVE THESE INSTRUCTIONS

-  Liquids, such as water, coffee, or tea are able to be overheated beyond the boiling point without appearing to be boiling. Visible bubbling or boiling when the container is removed from the microwave oven is not always present. THIS COULD RESULT IN VERY HOT LIQUIDS SUDDENLY BOILING OVER WHEN THE CONTAINER IS DISTURBED OR A SPOON OR OTHER UTENSIL IS INSERTED INTO THE LIQUID.

Carefully remove container coverings, directing steam away from hands and face.

Some items, like whole eggs and food in sealed containers, may explode if heated in this oven.

-  Do not operate this appliance if it has a damaged cord or plug, if it is not working properly, or if it has been damaged.

Do not cover or block any of the openings on this appliance.

Do not store this appliance outdoors. Do not use near water - for example, near a kitchen sink, in a wet basement, or near a swimming pool, etc.

Do not immerse cord or plug in water.

Do not let cord hang over edge of table or counter.

Do not try to preheat oven or operate while empty.

Do not cook without the glass tray in place on the oven floor. Food will not cook properly without the tray.

Do not defrost frozen beverages in narrow-necked bottles. The containers can break.

Dishes and containers can become hot. Handle with care.

Do not operate any other heating or cooking appliance beneath this appliance.

Do not mount unit over or near any portion of a heating or cooking appliance.

Do not mount over a sink.



Do not store anything directly on top of the appliance when it is in operation.

-  This appliance should be serviced only by qualified service personnel. Contact the nearest authorized service facility for examination, repair, or adjustment.

SAVE THESE INSTRUCTIONS

IMPORTANT SAFETY INSTRUCTIONS, CONTINUED

TO REDUCE THE RISK OF FIRE IN THE OVEN:

-  Remove wire twist-ties from plastic cooking bags before placing bags in oven.
-  Do not use the oven compartment for storage purposes. Do not leave paper products, cooking utensils, or food in the oven when not in use.

Do not overcook food. Watch appliance carefully if paper, plastic, or other combustible materials are inside.
-  If materials inside the oven ignite, keep the oven door closed, turn the oven off, disconnect the power cord, or shut off the power at the fuse or circuit breaker panel. If the door is opened, the fire may spread.

TO REDUCE THE RISK OF INJURY TO PERSONS:

-  Stir the liquid both before and halfway through heating it.

After heating, allow the container to stand in the microwave oven for a short time before removing the container.
-  Do not use straight-sided containers with narrow necks.



Do not overheat the liquid.
-  Use extreme care when inserting a spoon or other utensil into the container.

SAVE THESE INSTRUCTIONS

IMPORTANT GROUNDING INSTRUCTIONS

-  This appliance must be grounded. In the event of an electrical short circuit, grounding reduces the risk of electric shock by providing an escape wire for the electrical current. This appliance is equipped with a cord that includes a grounding wire and a grounding plug. The plug must be plugged into an outlet that is properly installed and grounded. Plug the three-prong power cord into a properly grounded outlet of standard 115-120 voltage, 60 Hz. Your oven should be the only appliance on this circuit.

WARNING

-  Improper use of the grounding plug can result in a risk of electric shock. Consult a qualified electrician or servicer if you do not understand the grounding instructions or if you are not sure if the appliance is properly grounded.
-  Do not use an extension cord with this appliance. If the power cord is too short, have a qualified electrician or service technician install an outlet near the appliance.

Do not cut or remove the third (ground) prong from the power cord under any circumstances.
-  Connect the oven only to a 15A dedicated circuit.



THE VENT FAN

-  The fan will operate automatically under certain conditions. Take care to prevent the starting and spreading of accidental cooking fires while the vent fan is in use.

In the event of a grease fire on the surface units below the microwave oven, smother a flaming pan on the surface unit by covering the pan completely with a lid, a cookie sheet or a flat tray.

Clean Ventilating Hoods Frequently - Grease should not be allowed to accumulate on hood or filter.

When flaming foods under the hood, turn the fan on.

-  Use care when cleaning the vent-hood filter. Corrosive cleaning agent, such as lye-based oven cleaner, may damage the filter.
-  Never leave surface units beneath your microwave oven unattended at high heat settings. Boilovers cause smoking and greasy spillovers that may ignite and spread if the microwave vent fan is operating. To minimize automatic fan operation, use adequate sized cookware and use high heat on surface units only when necessary.

SAVE THESE INSTRUCTIONS

contents

YOUR NEW MICROWAVE OVEN

10

- 10 Checking parts
- 11 Warranty and service information
- 11 Setting up your microwave oven
- 12 Control panel feature

BEGINNING

14

- 14 Turning on the power
- 14 Using the my choice feature
- 15 Setting the clock
- 15 Setting the child protection lock

QUICK GUIDE

16

- 16 Using the your new microwave oven

OPERATING THE OVEN

17

- 17 Using the help button
- 17 Using the pause/cancel button
- 17 Using the kitchen timer
- 17 Using the one minute+ button
- 17 Using the more/less buttons
- 18 Using the sensor cook buttons
- 18 Using the sensor reheat button
- 18 Using the power/auto defrosting
- 19 Using the handy helper button
- 20 Using the kids meals button
- 21 Using the snack bar button
- 22 Setting cooking times & power levels
- 23 Setting and using the custom cook button
- 23 Turning the Turntable On/Off
- 23 Turning the Light On/Night/Off
- 23 Turning the Vent Fan Turbo/Hi/Low/Off
- 24 Using the metal shelf

COOKING INSTRUCTIONS

25

- 25 Cooking utensils
- 26 Testing utensils
- 26 General microwave tips
- 27 Cooking techniques
- 28 Auto sensor cook
- 28 Utensils & cover for sensor cooking
- 29 Sensor Cooking Guide
- 30 Sensor Reheat Guide
- 30 Power/Auto Defrosting Guide
- 31 Cooking Guide
- 34 Recipes

MAINTENANCE

36

- 36 Troubleshooting
- 37 Care and Cleaning
- 38 Light bulb replacement
- 39 The vent fan
- 41 Specifications

WARRANTY

42

your new microwave oven

CHECKING PARTS

Unpack your microwave oven and check to make sure that you have all the parts shown here. If any part is missing or broken, call your dealer.

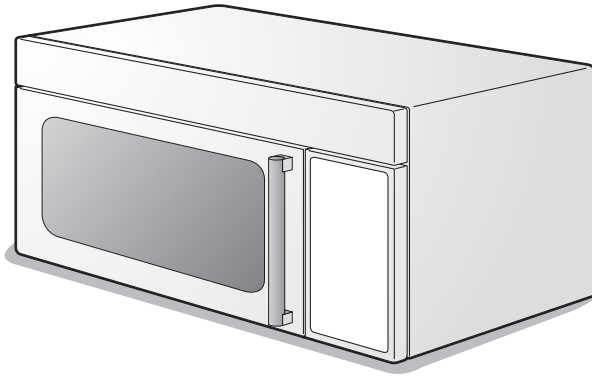

Microwave oven

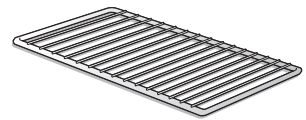

Shelf

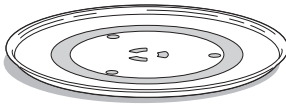

Glass Tray



Roller Guide Ring

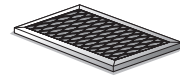

Charcoal filter

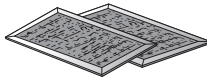

Grease Filters (2ea)

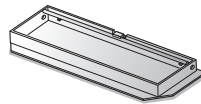

Exhaust adaptor



Hardware-kit

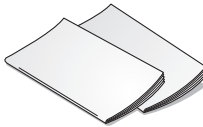

**Manuals
(User & Installations)**

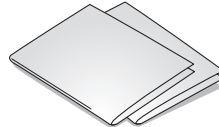

Templates (Top & Wall)

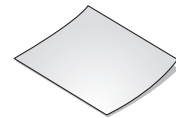

Registration Card

WARRANTY AND SERVICE INFORMATION

To help us to serve you better, please complete the enclosed registration card and promptly return it by mail. If the registration card is missing, you can call Samsung Electronics Canada, Inc., at **1-800-SAMSUNG (7267864)**.

When contacting Samsung, please provide the specific model and serial number information which is usually located on the back or bottom of the product. Please record these numbers below, along with the other requested information. Keep this information in a safe place as a permanent record of your purchase to aid in identification in case of theft or loss, and a copy of your sales receipt as a proof of purchase if warranty service is needed.

MODEL NUMBER _____
SERIAL NUMBER _____
DATE PURCHASED _____
PURCHASED FROM _____

Warranty service can only be performed by a Samsung Authorized Service Center. If you should require warranty service, provide the above information with a copy of your sales receipt to the Samsung Authorized Service Center.

For service assistance and the location of the nearest service center, please call **1-800-SAMSUNG (7267864)**.

SETTING UP YOUR MICROWAVE OVEN

1. Open the oven door by pulling the handle on the right side of the door.

2. Wipe the inside of the oven with a damp cloth.

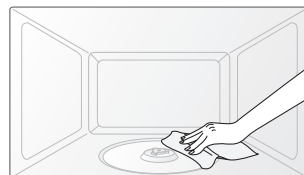

3. Place the pre-assembled ring in the indentation in the center of the oven.

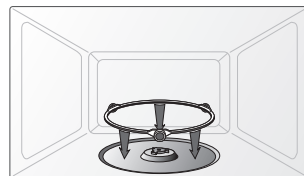

4. Place the glass tray securely in the center of the pre-assembled roller guide.

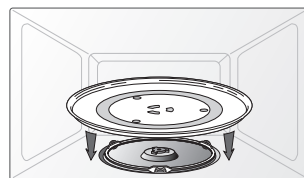

CONTROL PANEL FEATURES

READ THE INSTRUCTIONS CAREFULLY BEFORE USING THE MICROWAVE OVEN. For satisfactory use of your oven, become familiar with the various features and functions of the oven as described below. Detailed instructions for each feature and function follow later in this user manual.

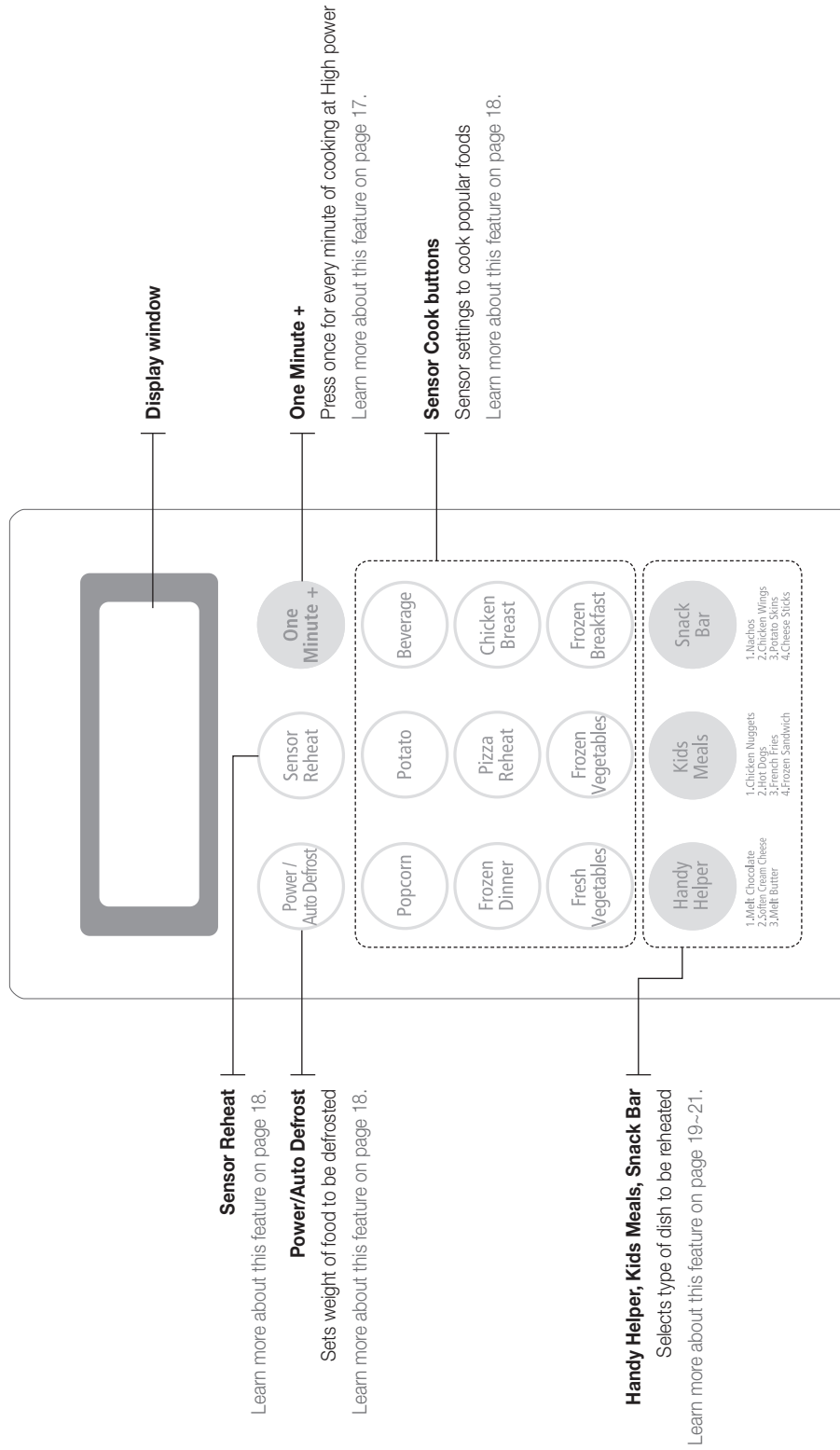

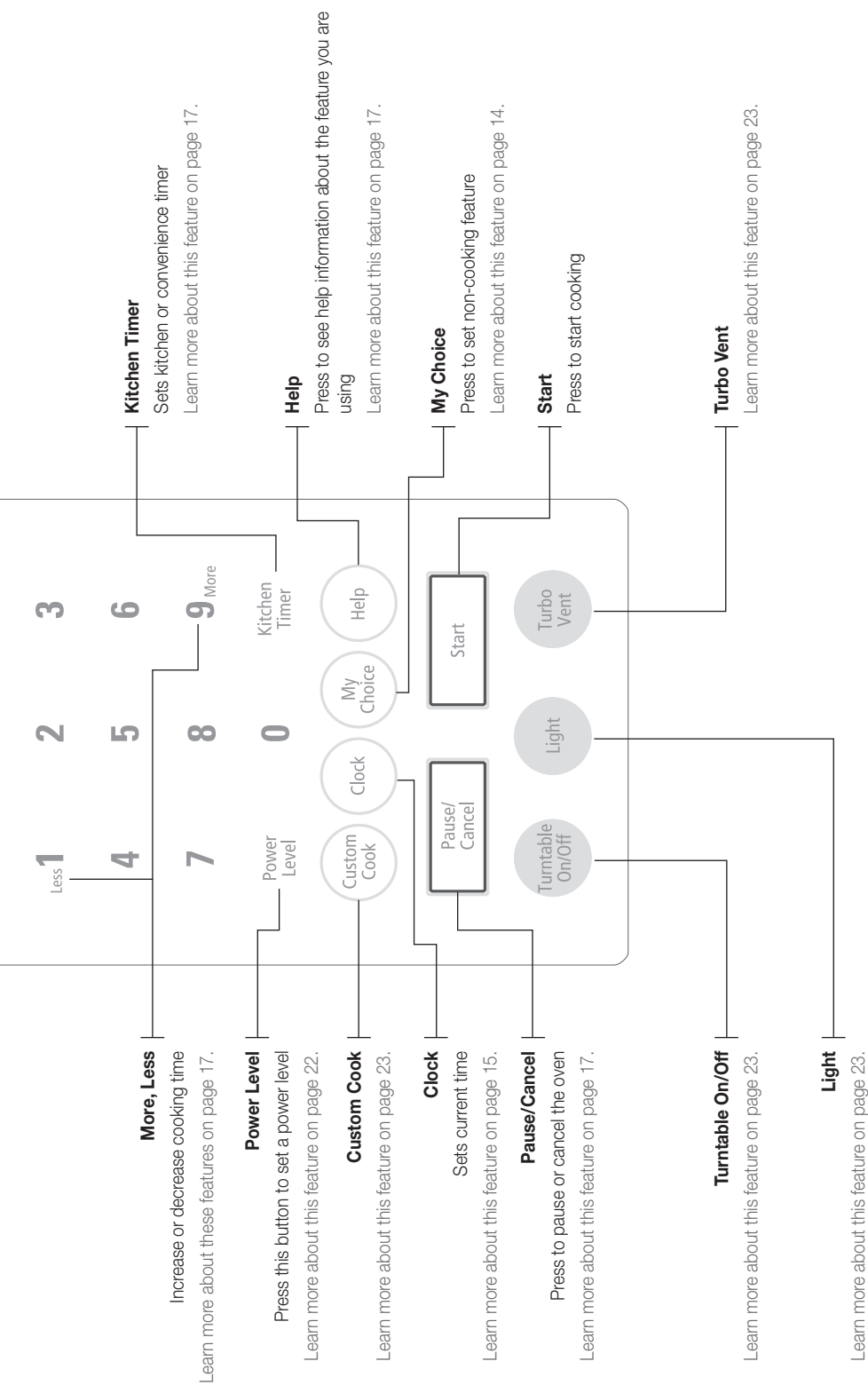

TURNING ON THE POWER

The first time you plug the power cord into an outlet, or after there has been an interruption in power, the display shows after four seconds *ENJOY YOUR COOKING -- -- -- PRESS MY CHOICE FOR PERSONAL OPTIONS.*

USING THE MY CHOICE FEATURE

Your new microwave oven can be customized to suit your personal tastes. Simply press **MY CHOICE** to set these options. For your convenience, all the options are summarized in the following table:

NUMBER	MY CHOICE OPTIONS	DESCRIPTION
1	Language choice	Language options are english, french and spanish.
2	Display weight	Weight options are pounds or kilograms.
3	Remind end signal	The remind end signal can be turned on and off.
4	Daylight savings time adjustment	The time can be advanced one hour for dst without resetting the clock.

Selecting a display language

1. Press **MY CHOICE** button immediately after plugging in your microwave and then press number **1** button. The display will show: *LANGUAGE CHOICE PRESS MY CHOICE*
3. Press **MY CHOICE** button. The display will show: *ENGLISH PRESS START*
4. Press **MY CHOICE** button repeatedly to select the language you wish to use.
 - If you continue to press My Choice, the settings will cycle in the order shown here: *ENGLISH, FRENCH, SPANISH*
5. Press the **START** button.

Selecting the display weight

You can choose between pounds(LBS) and kilograms(KG).

1. Press **MY CHOICE** button and then press the number **2** button. The display shows: *LBS OR KG PRESS MY CHOICE*
2. Press **MY CHOICE** button. The display shows: *LBS*
3. Press the **MY CHOICE** button repeatedly to select the weight measurements you wish to use.
4. Press the **START** button.

Setting the remind end signal

The Remind End Signal can be set On or Off.

1. Press the **MY CHOICE** button and then press number **3** button. The display shows: *REMIND END SIGNAL ON/OFF PRESS MY CHOICE*
2. Press the **MY CHOICE** button to select ON. The display shows: *ON*
3. Press the **START** button. The display returns to the time of day.
 - To turn Remind End Signal off, repeat steps 1-3 above.

Setting the daylight saving time adjustment

1. Press the **MY CHOICE** button and then number **4** button. The display will show: *DAYLIGHT SAVING TIME ON/OFF PRESS MY CHOICE*
2. Press the **MY CHOICE** button to select ON. Press **MY CHOICE** button again to select OFF.
3. Press the **START** button. Time of day will advance one hour. If OFF is selected, time will go back one hour.
 - If the clock is set for standard time, this function allows convenient time changes without needing to reset the clock. Daylight Saving Time begins for most of the United States at 2 a.m. on the first Sunday of April, and reverts to Standard time at 2 a.m. on the last Sunday of October.

SETTING THE CLOCK

1. Press the **CLOCK** button. The display will show: *SELECT AM/PM*
2. To select AM or PM, press the **CLOCK** button.
3. Use the number buttons to enter the current time. You must press at least three numbers to set the clock. For example, if the current time is 5:00, enter 5,0,0. The display will show: *500*
4. Press **CLOCK** again. A colon will appear, indicating that the time is set.
 - If there is a power interruption, you will need to reset the clock.
 - You can check the current time while cooking is in progress by pressing the Clock button.

SETTING THE CHILD PROTECTION LOCK

You can lock your microwave oven so it can't be used by unsupervised children.

1. Press the **MY CHOICE** button and the number **5** button at the same time for 3 seconds. The display shows : *CHILD LOCK ON*
2. The display returns to the time of day.
 - At this point, the microwave oven cannot be used until it is unlocked. To unlock it, repeat steps 1-2 above.

quick guide

USING THE YOUR NEW MICROWAVE OVEN

One minute cooking

1. Press the **ONE MINUTE +** button once for each minute of cooking.
2. The time will display and the oven will start.
 - See page 17 for more informations

Sensor Cook

1. Press button that corresponds to the food you are cooking (for example **POTATO**).
2. The display will show the food you have chosen and the oven will start automatically.
 - See page 18 for more informations

Sensor Reheat

1. Press **SENSOR REHEAT** button.
2. The display will show *REHEAT* and the oven will start automatically.
 - See page 18 for more informations

Defrost

1. Press **POWER/AUTO DEFROST** button.
2. Enter weight of food by pressing **POWER/AUTO DEFROST** button repeatedly or using the number buttons.
3. When the oven beeps, turn food over. Press **START** to resume defrosting cycle.
 - See page 18 for more informations

Handy Helper, Kids Meals, Snack Bar

1. Press **HANDY HELPER** or **KIDS MEALS** or **SNACK BAR** button repeatedly to select type of dish to reheat.
2. To increase serving size, press the corresponding number button.
3. Press **START** button to begin cooking.
 - See page 19~21 for more informations

Set cooking time and power levels

1. Use number buttons to set cooking time.
2. To set power level at other than HIGH, press **POWER LEVEL** and use the number buttons to enter the power level.
3. Press **START** to begin cooking.
 - See page 22 for more informations

operating the oven

USING THE HELP BUTTON

Your microwave offers helpful instructions for many procedures.

When you need feature information and helpful hints, press the **HELP** button and then press the button that you want to get information on. Help information is available in 3 languages (English, French and Spanish).

USING THE PAUSE/CANCEL BUTTON

The PAUSE/CANCEL button allows you to clear instructions you have entered. It also allows you to pause the oven's cooking cycle, so that you can check the food.

- To pause the oven during cooking: press **PAUSE/CANCEL** button once. To restart, press **START** button.
- To stop cooking, erase instructions, and return the oven display to the time of day: press **PAUSE/CANCEL** button twice.
- To clear instructions you have just entered: press **PAUSE/CANCEL** button once, then re-enter the instructions.
- To cancel a timer setting: press **PAUSE/CANCEL** button once.

USING THE KITCHEN TIMER

1. Use the number buttons to set the length of time you want the timer to run.
2. Press the **KITCHEN TIMER** button.
3. The display counts down and beeps when the time has elapsed.
4. To cancel timer setting: Press **PAUSE/CANCEL** button twice.

USING THE ONE MINUTE+ BUTTON

This button offers a convenient way to heat food in one minute increments at the High power level.

1. Press the **ONE MINUTE+** button once for each minute you wish to cook the food. For example, press it twice for two minutes. The time will display, and the oven starts automatically.
2. Add minutes to a program in progress by pressing the **ONE MINUTE+** button for each minute you want to add.

USING THE MORE/LESS BUTTONS

The MORE/LESS buttons allow you to adjust pre-set cooking times. They only work in the **Sensor Reheat, Sensor Cooking(except Beverage), One minute +, Custom Cook, Kitchen Timer, Handy Helper, Kids Meals, Snack Bar** or **Time Cook** modes. Use the MORE/ LESS button only after you have already begun cooking with one of these procedures.

1. To add more time to an automatic cooking procedure: Press the **MORE(9)** button.
2. To reduce the time of an automatic cooking procedure: Press the **LESS(1)** button.

USING THE SENSOR COOK BUTTONS

By actually sensing the humidity that escapes as food heats, this feature automatically adjusts the oven's heating time for various types and amounts of food.

- Press the **SENSOR COOK** button corresponding to the food you are cooking (**POTATO**, for example). The display shows *POTATO* and your microwave oven will begin cooking automatically.
- When cooking popcorn, wait at least five minutes between each bag to avoid overheating the glass tray. If you want to adjust the cooking time, you can use the **MORE** or **LESS** buttons. If you want to check the current time while cooking is in progress, press the **CLOCK** button.

See "Sensor cooking guide" on page 29 for more informations.

USING THE SENSOR REHEAT BUTTON

Heating leftovers and precooked foods is easy with your new microwave. By actually sensing the humidity that escapes as food heats, this feature automatically adjusts the oven's heating time for various types and amounts of precooked food. All food should be precooked. Plate of food and casserole should be stored at refrigerator temperature. To use sensor reheating:

- Press **SENSOR REHEAT** button. The display will show *REHEAT* and the oven will start automatically.
- If you want to adjust the heating time, use the **MORE/LESS** buttons.
- If you want to check the current time while reheating, press the **CLOCK** button.

See "Sensor reheat guide" on page 30 for more informations.

USING THE POWER/AUTO DEFROSTING

To thaw frozen food, set the weight of the food and the microwave automatically sets the defrosting time, power level and standing time.

The Power Defrost function will automatically activate when defrosting foods that weigh less than 1.0 lbs.

The Auto Defrost function will automatically activate when desfrosting foods that weight over 1.0 lbs.

- Please note that Auto Defrost function (function that defrosts foods which weigh more than 1.0 lbs) will take several minutes longer than the Power Defrost function (function that defrosts foods which weigh less than 1.0 lbs).

1. Press the **POWER/AUTO DEFROST** button. The display shows : *0.5 LB (0.2Kg)* if you have set your oven for metric measure).
2. To set the weight of your food, press the **POWER/AUTO DEFROST** repeatedly. This increases the weight by 0.5 lb increments, up to 6.0 lbs. You can also use the number buttons to enter the weight of the food directly. The oven calculates the defrosting time and starts automatically.
- Twice during defrosting, the oven will beep and the display will read *TURN THE FOOD OVER*
3. Open the oven door, and turn the food over.
4. Press the **START** button to resume defrosting.



Even if you do not turn the food over when *TURN THE FOOD OVER* is displayed.

See "Power/auto defrosting guide" on page 30 for more informations.

USING THE HANDY HELPER BUTTON

1. Press the **HANDY HELPER** button corresponding to the food you are cooking. The display shows: *MELT CHOCOLATE 1CUP CHIPS*.
 - Press the **HANDY HELPER** button repeatedly to select the item you want. (Refer to the handy helper chart)
2. Press the number **1** or **2** button to select the serving size you want. Only the number **1** button (serving) is available for Soften Cream Cheese and Melt Chocolate items. (Refer to the handy helper chart for the serving)
3. Press the **START** button to begin cooking.

Handy helper chart

ITEM	AMOUNT	REMARKS
Melt chocolate	1 cup chips or 1 square	Place chocolate chips or square in a microwave-safe container. When oven beeps, stir chocolate and re-start oven. Stir and let stand 1 minute.
Soften cream cheese	8-oz package	Unwrap cream cheese and place on microwave-safe container. Cut in half vertically. Let stand 2 minutes.
Melt butter	1 stick 2 sticks	Unwrap butter and place in a microwave-safe container. Cut in half vertically. Cover with wax paper. Let stand 2 minutes, then stir

USING THE KIDS MEALS BUTTON

1. Press the **KIDS MEALS** button corresponding to the food you are cooking. The display shows: *CHICKEN NUGGETS*
 - Press the **KIDS MEALS** button repeatedly to select the item you want. (Refer to the kids meals chart.)
2. Press the number **1** or **2** button to select the serving size you want. (Refer to the kids meals chart for the serving.)
3. Press the **START** button to begin cooking.

Kids meals chart

ITEM	AMOUNT	REMARKS
Chicken nuggets (frozen)	1 serving 2 servings	Put a paper towel on top of plate and arrange nuggets in spoke fashion. Do not cover. Let stand 1 minute after heating. NOTE: Refer to package directions for serving size and amount of food. Use the More button if chicken nuggets are not hot enough.
Hot dogs	2 hot dogs 4 hot dogs	Prick hot dogs and place on plate When oven beeps, add buns and re-start oven. Let stand 1 minute after heating. NOTE: For the best texture, buns should be added to hot dogs when the oven beeps.
French fries (frozen)	1 serving 2 servings	Place 2 paper towels on microwave-safe plate. Arrange french fries on towels. Do not overlap. After cooking, blot with additional paper towel. Let stand 1 minute after heating. NOTE: Refer to package directions for serving size and amount of food.
Frozen sandwiches (in crisping sleeve) 9-oz package size	1 sandwich 2 sandwiches	Place frozen sandwich in susceptor "crisping sleeve" packaged with sandwich. Place on microwave-safe plate. Remove from "crisping sleeve". Let stand 2 minutes after heating. NOTE: For larger size sandwiches, use the MORE button to increase the heating time.

USING THE SNACK BAR BUTTON

1. Press the **SNACK BAR** button corresponding to the food you are cooking. The display shows:
NACHOS 1 SERVING
 - Press the **SNACK BAR** button repeatedly to select the item you want. (Refer to the snack bar chart)
2. Press the number **1** or **2** button to select the serving size you want. Only the number **1** button(serving) is available for Nachos. (Refer to the snack bar chart for the serving)
3. Press **START** button to begin cooking.

Snack bar chart

ITEM	AMOUNT	REMARKS
Nachos	1 serving	Place tortilla chips on plate without overlapping. Sprinkle evenly with cheese. CONTENTS: <ul style="list-style-type: none"> • 2 cups tortilla chips • 1/3 cup grated cheese
Chicken wings	5-6 oz. 7-8 oz.	Use pre-cooked, refrigerated chicken wings. Place chicken wings around plate in spoke fashion. Cover with wax paper. Let stand 1 to 2 minutes after heating.
Potato skins	1 cooked potato 2 cooked potatoes	Cut cooked potato into 4 even wedges. Scoup or cut out potato flesh, leaving about 1/4" of skin. Place skins in spoke fashion around plate. Sprinkle with bacon, onions and cheese. Do not cover. Let stand 1 to 2 minutes after heating.
Cheese sticks (frozen)	5-7 pcs 8-10 pcs	Place cheese sticks on plate in spoke fashion. Do not cover. Let stand 1 to 2 minutes after heating. NOTE: Sizes of cheese stick vary. For smaller size cheese nuggets, use the LESS button to decrease the heating time. For larger size cheese sticks, use the MORE button to increase heating time.

SETTING COOKING TIMES & POWER LEVELS

Your microwave allows you to set up to three different stages of cooking, each with its own time length and power level. The power level lets you control the heating intensity from Warm (1) to High (0).

One-stage cooking

For simple one-stage cooking, you only need to set a cooking time. The power level is automatically set at High. If you want the power set at any other level, you must set it using the **POWER LEVEL** button.

1. Use the number buttons to set a cooking time. You can set a time from one second to 99 minutes, 99 seconds. To set a time over one minute, enter the seconds too. (For example, to set 20 minutes, enter **2, 0, 0, 0**.)
2. If you want to set the power level to something other than High, press the **POWER LEVEL** button, then use the number buttons to enter a power level. The display shows: *PRESS START OR ENTER NEXT STAGE COOKING TIME*.

POWER LEVEL			
1	Warm	6	Simmer
2	Low	7	Medium high
3	Deforst	8	Reheat
4	Medium low	9	Saute
5	Medium	0	High

3. Press the **START** button to begin cooking. If you want to change the power level, press **PAUSE/CANCEL** button before you press the **START** button, and re-enter all of the instructions.
 - Some recipes require different stages of cooking at different temperatures. You can set multiple stages of cooking with your microwave.

Multi-stage cooking

1. Follow steps 1 and 2 in the “**One-stage cooking**” section. *PRESS START OR ENTER NEXT STAGE COOKING TIME* appears in the display.
 - When entering more than one cooking stage, the Power Level button must be pressed before the second cooking stage can be entered.
 - To set the power level at High for a stage of cooking, press the Power Level button twice.
2. Use the number buttons to set a second cooking time.
3. Press the **POWER LEVEL** button, then use the number buttons to set the power level of the second stage of cooking. The display shows the power level you have set and *PRESS START OR ENTER NEXT STAGE COOKING TIME*.
4. Press the **START** button to begin cooking, or repeat steps 2 and 3 to set a cooking time and power level for a third stage of cooking. When finished, press **START** button.

SETTING AND USING THE CUSTOM COOK BUTTON

The Custom button memorizes the time and power setting for a particular food.

Programming the Custom Cook button

1. Press the **CUSTOM COOK** button. Press the button twice to delete the previous Custom setting. The display shows: *ENTER COOKING TIME AND POWER*
2. Use the number buttons to enter the amount of cooking time. The display will show the amount of time you have set.
3. Press the **POWER LEVEL** button and use the number buttons to enter the power level. The display will show the power level you have set. You can set the power level from 0 to 9. (Refer page 22 for more informations.)
4. Press the **CUSTOM COOK** button again. The display will read *CUSTOM RECIPE SAVED*.

Using the Custom Cook button

Press the **Custom Cook** button, then press **Start** button. You can check the power level while cooking is in progress by pressing the **Power Level** button.

TURNING THE TURNTABLE ON/OFF

- For best cooking results, leave the turntable on.
- It can be turned off for large dishes.
- Press **TURNTABLE ON/OFF** button to turn the turntable on or off.
- Sometimes the turntable can become too hot to touch. Use pot holders touching the turntable during and after cooking.

TURNING THE LIGHT ON/NIGHT/OFF

- Press the **LIGHT** button to adjust the light or turn it on/off.
- Press the **LIGHT** button once for on light, twice for the night light and three times to turn the light off.

TURNING THE VENT FAN TURBO/HI/LOW/OFF

- The vent fan removes steam and other vapors from surface cooking.
- Press **TURBO VENT** button once for turbo fan speed, twice for high fan speed and three times for low fan speed or four times to turn the fan off.



The Vent Fan protects the microwave from too much heat rising from the cooktop below it. It automatically turns on if it senses too much heat. If you have turned the fan on, you may find that you cannot turn it off. The fan will automatically turn off when the internal parts are cool. It may stay on for 30 minutes or more after the cooktop and microwave controls are turned off. The Vent Fan will operate only in Hi/Low/Off mode while the microwave is working.

USING THE METAL SHELF

How to use the metal shelf when microwaving

- Make sure the shelf is positioned properly inside the microwave to prevent damage to the oven from arcing.
- Do not use a microwave browning dish on the shelf. The shelf could overheat.
- Do not use the oven with the shelf on the microwave floor. This could damage the microwave.
- Use pot holders when handling the shelf-it may be hot.
- Do not use the metal shelf when cooking popcorn.

Food microwaves best when placed on the turntable or on the shelf in the lower position.

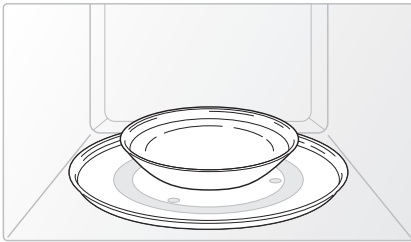

For best results

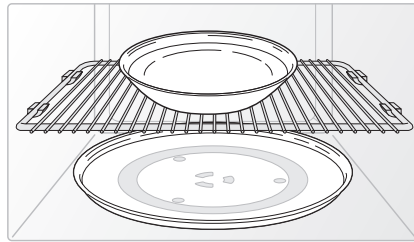

Uneven results

The shelf gives you the option to reheat more than one dish of food at the same time.

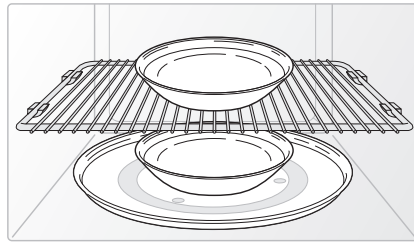
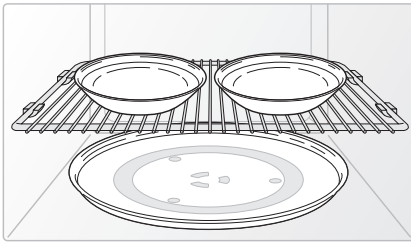

Shelf and reheating

To reheat on 2 levels or to reheat dishes on the lower level:

- Multiply reheat time by 1½.
- Switch places after ½ the time.

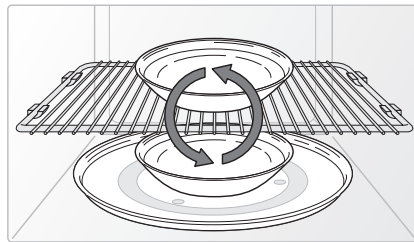
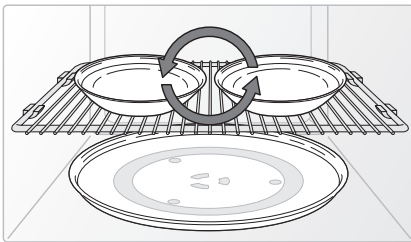

cooking instructions

COOKING UTENSILS

Recommended use

- **Ceramic and glass** - ceramic bowls and dishes - Use for heating or cooking.
- **Microwavable plastic wrap** - Use to cover. Leave a small opening for some steam to escape and avoid placing it directly on the food.
- **Wax paper** - Use as a cover to prevent spattering.
- **Paper towels and napkins** - Use for short-term heating and covering; they absorb excess moisture and prevent spattering. Do not use recycled paper towels, which may contain metal and can catch fire.
- **Paper plates and cups** - Use for short-term heating at low temperatures. Do not use recycled paper, which may contain metal and can catch fire.
- **Thermometers** - Use only those labeled "Microwave-Safe" and follow all directions. Check the food in several places. Conventional thermometers may be used once the food has been removed from the oven.

Limited use

- **Aluminum foil** - Use narrow strips of foil to prevent overcooking of exposed areas. Using too much foil can damage your oven, so be careful.
- **Ceramic, porcelain, and stoneware** - Use these if they are labeled "Microwave-Safe". If they are not labeled, test them to make sure they can be used safely. Never use dishes with metallic trim.
- **Plastic** - Use only if labeled "Microwave-Safe". Other plastics can melt.
- **Straw, wicker, and wood** - Use only for short-term heating, as they can be flammable.

Not recommended

- **Glass jars and bottles** - Regular glass is too thin to be used in a microwave, and can shatter.
- **Paper bags** - These are a fire hazard, except for popcorn bags that are designed for microwave use.
- **Styrofoam plates and cups** - These can melt and leave an unhealthy residue on food.
- **Plastic storage and food containers** - Containers such as margarine tubs can melt in the microwave.
- **Metal utensils** - These can damage your oven. Remove all metal before cooking.

TESTING UTENSILS

If you are not sure whether a dish is microwave-safe or not, you can perform this test:

1. Fill 1 cup of glass measuring cup with water and put it inside your oven, next to the dish you want to test.

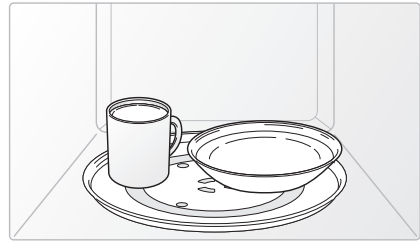

2. Press the **ONE MINUTE +** button once to heat them for one minute at High power.

The water should be warm and the dish you are testing should be cool. If the dish is warm, then it is absorbing microwave energy and is not acceptable for use in the microwave.

GENERAL MICROWAVE TIPS

- Dense foods, such as potatoes, take longer to heat than lighter foods. Foods with a delicate texture should be heated at a low power level to avoid becoming tough.
- Altitude and the type of cookware you are using can affect cooking time. When using a new recipe, use the minimum cooking time and check the food occasionally to prevent overcooking.
- Foods with a non-porous skin such as potatoes or hot dogs, should be pierced to prevent bursting.
- Frying with heating oil or fat is not recommended. Fat and oil can suddenly boil over and cause severe burns.
- Some ingredients heat faster than others. For example a jelly doughnut will be hotter than the dough. Keep this in mind to avoid burns.
- Home canning in the microwave oven is not recommended because all harmful bacteria may not be destroyed by the microwave heating process.
- Although microwaves do not heat the cookware, the heat from the food is often transferred to the cookware. Always use pot holders when removing food from the microwave and instruct children to do the same.
- Making candy in the microwave is not recommended as candy can be heated to very high temperatures. Keep this in mind to avoid injury.

COOKING TECHNIQUES

Stirring

Stir foods such as casseroles and vegetables while cooking to distribute heat evenly. Food at the outside of the dish absorbs more energy and heats more quickly, so stir from the outside to the center. The oven will turn off when you open the door to stir your food.

Arrangement

Arrange unevenly shaped foods, such as chicken pieces or chops, with the thicker, meatier parts toward the outside of the turntable where they receive more microwave energy. To prevent overcooking, place thin or delicate parts toward the center of the turntable.

Shielding

Shield food with narrow strips of aluminum foil to prevent overcooking. Areas that need shielding include poultry wing-tips, the ends of poultry legs, and corners of square baking dishes. Use only small amounts of aluminum foil. Larger amounts can damage your oven.

Turning

Turn foods over midway through cooking to expose all parts to microwave energy. This is especially important with large items such as roasts.

Standing

Foods cooked in the microwave build up internal heat and continue to cook for a few minutes after the oven stops. Let foods stand to complete cooking, especially foods such as roasts and whole vegetables. Roasts need this time to complete cooking in the center without overcooking the outer areas. All liquids, such as soup or hot chocolate, should be shaken or stirred when cooking is complete. Let liquids stand a moment before serving. When heating baby food, stir well and test the temperature before serving.

Adding moisture

Microwave energy is attracted to water molecules. Food that is uneven in moisture content should be covered or allowed to stand so that the heat disperses evenly. Add a small amount of water to dry food to help it cook.

Venting

After covering dish with plastic wrap, you vent plastic wrap by turning back one corner so excess steam can escape.

AUTO SENSOR COOK

The Auto Sensor allows you to cook your food automatically by detecting the amount of humidity generated from the food while cooking.

- When cooking food, the humidity is generated. The Auto Sensor determines the proper time and power level by detecting the humidity from the food, eliminating the need to set the cooking time and power level.
- When you cover a container with its lid or plastic wrap during Sensor Cooking, the Auto Sensor will detect the humidity generated after the container has been saturated with steam.
- Shortly before cooking ends, the remaining cooking time will begin its count down. This will be a good time for you to rotate or stir the food for even cooking if it is necessary.
- Before auto sensor cooking food may be seasoned with herbs, spices or browning sauces. A word of caution though, salt or sugar may cause burn spots on food so these ingredients should be added after cooking.
- The MORE/LESS buttons is used to increase or decrease cooking time. You should use this function to adjust the degree of cooking to suit your personal taste.

UTENSILS & COVER FOR SENSOR COOKING

- To obtain good cooking results with this function, follow the directions for selecting appropriate containers and covers in the charts in this book.
 - Always use microwave-safe containers and cover them with their lids or with plastic wrap. When using plastic wrap, turn back one corner to allow steam to escape at the proper rate.
 - Always cover with the lid intended for the utensil being used. If the utensil does not have its own lid, use plastic wrap.
 - Fill containers at least half full.
 - Foods that require stirring or rotating should be stirred or turned at the end of the Sensor Cook cycle, when the time has started to count down on the display.
-  • It is not advisable to use the Auto Sensor cooking feature on a continuous cooking operation, i.e. one cooking operation immediately after another.
- Install the oven in a well ventilated location for proper cooling and airflow and to ensure the sensor will operate accurately.
 - To avoid poor results, do not use the Auto Sensor when the room ambient temperature is too high or too low.
 - Avoid placing the oven near high moisture appliances, since this will interfere with the proper performance of the Auto Sensor.
 - Always keep the inside of the oven clean. Wipe all spills with a damp cloth.
 - This oven is designed for household use only.

SENSOR COOKING GUIDE

Follow the instructions below when sensor cooking different types of food.

FOOD	AMOUNT	PROCEDURE
Popcorn	3.0 - 3.5 oz 1 package	Use only one microwave-only bag of popcorn at a time. Use caution when removing and opening the hot bag from oven. Let oven cool for at least 5 minutes before using again.
Potatoes	1 to 6 potatoes.	Prick each potato several times with fork. Place on turntable in spoke-like fashion. Let stand 3-5 minutes. Let oven cool for at least 5 minutes before using again.
Beverage	8 oz.	Use measuring cup or mug ; do not cover. Place the beverage in the oven. After heating, stir well. Let oven cool for at least 5 minutes before using again.
Frozen dinner	8 to 14 oz.	Remove food from outer wrapping and follow box instructions for covering and standing. Let oven cool for at least 5 minutes before using again.
Pizza reheat	1 to 3 slices	Put 1-3 slices of pizza on a microwave-safe plate with wide end of slice towards the outside edge of the plate. Do not let slices overlap. Do not cover. Let oven cool for at least 5 minutes before using again. Use MORE button to increase reheat time for thick crust pizza.
Frozen vegetables	1 to 4 servings	Place frozen vegetables in microwave-safe ceramic, glass or plastic dish and add 2-4 Tbs. water. Cover with lid or vented plastic wrap during cooking and stir before standing. Let oven cool for at least 5 minutes before using again.
Chicken breast	8 to 16 oz.	Place chicken breasts on a microwave safe plate and cover with plastic wrap. Cook to an internal temperature of 170 degrees F. Let stand 5 minutes. Use the MORE button to increase cooking time for larger or thicker chicken breasts.
Frozen breakfast	4 to 8 oz.	Follow package instructions for covering and standing. Use this button for frozen sandwich, breakfast entree, pancakes, waffles, etc. Let oven cool for at least 5 minutes before using again.
Fresh vegetables	1 to 4 cups	Place fresh vegetables in microwave-safe ceramic, glass or plastic dish and add 2-4 Tbs. water. Cover with lid or vented plastic wrap during cooking and stir before standing. Let oven cool for at least 5 minutes before using again.



Desired food temperature varies from person to person. Use the **MORE/LESS** buttons to fit your temperature preference.

SENSOR REHEAT GUIDE

Follow the instructions below when sensor reheating different types of food.

FOOD	AMOUNT	PROCEDURE
Plate of food	1 serving (1 plate).	Use only pre-cooked, refrigerated foods. Cover plate with vented plastic wrap or waxed paper, tucked under plate. If food is not as hot as you prefer after heating with Sensor Reheat , continue heating using time and power. CONTENTS <ul style="list-style-type: none"> • 3-4 oz. meat, poultry or fish (up to 6 oz. with bone) • 1/2 cup starch (potatoes, pasta, rice, etc.) • 1/2 cup vegetables (about 3 - 4 oz.)
Casserole	1 to 4 servings.	Cover plate with lid or vented plastic wrap. If food is not as hot as you prefer after heating with Sensor Reheat , continue heating using time and power.
Pasta reheat		Stir foods once before serving. CONTENTS <ul style="list-style-type: none"> • Casserole-refrigerated foods. • Pasta-Canned spaghetti and ravioli.

POWER/AUTO DEFROSTING GUIDE

Follow the instructions below when defrosting different types of food.

FOOD	AMOUNT	PROCEDURE
Roast beef, pork	2.5-6.0 lbs.	Start with the food placed fat side down. After each stage, turn the food over and shield any warm portions with narrow strips of aluminum foil. Let stand, covered, for 10-20 minutes.
Steaks, chops, fish	0.5-3.0 lbs.	After each stage, rearrange the food. If there are any warm or thawed portions of food, shield them with narrow flat pieces of aluminum foil. Remove any pieces of food that are nearly defrosted. Let stand, covered, for 5-10 minutes.
Ground meat	0.5-3.0 lbs.	After each stage, remove any pieces of food that are nearly defrosted. Let stand, covered with foil, for 5-10 minutes.
Whole chicken	2.5-6.0 lbs.	Remove giblets before freezing poultry. Start defrosting with the breast side down. After the first stage, turn the chicken over and shield any warm portions with narrow strips of aluminum foil. After the second stage, again shield any warm portions with narrow strips of aluminum foil. Let stand, covered, for 30-60 minutes in the refrigerator.
Chicken pieces	0.5-3.0 lbs.	After each stage, rearrange or remove any pieces of food that are nearly defrosted. Let stand for 10-20 minutes.



Check foods when the oven signals. After the final stage, small sections may still be icy; let them stand to continue thawing. Do not defrost until all ice crystals have thawed. Shielding roasts and steaks with small pieces of foil prevents the edges from cooking before the center of the food has defrosted. Use narrow, flat, smooth strips of aluminum foil to cover the edges and thinner sections of the food.

COOKING GUIDE

Guide for cooking meat in your microwave

- Place meat on a microwave-safe roasting rack in a microwave-safe dish.
- Start meat fat-side down. Use narrow strips of aluminum foil to shield any bone tips or thin meat areas.
- Check the temperature in several places before letting the meat stand the recommended time.
- The following temperatures are removal temperatures. The temperature of the food will rise during the standing time.

FOOD	COOK TIME/POWER LEVEL	DIRECTIONS
Roast beef boneless Up to 4 lbs.	Cooking Time: 7-11 min. / lb. for 145° F - Rare 8-12 min. / lb. for 160° F - Medium 9-14 min. / lb. for 170° F - Well Done	Place roast fat-side down on roasting rack. Cover with wax paper. Turn over half way through cooking. Let stand 10 minutes.
	Power Level: High(0) for first 5 minutes, then Medium(5).	
Pork boneless or bone-in Up to 4 lbs.	Cooking Time: 11-15 min. / lb. for 170° F Well Done	Place roast fat-side down on roasting rack. Cover with wax paper. Turn over half way through cooking. Let stand 10 minutes.
	Power Level: High(0) for first 5 minutes, then Medium(5).	

Expect a 10°F rise in temperature during the standing time.

FOOD	REMOVE FROM OVEN	AFTER STANDING (10 MIN.)
Beef	Rare	135°F
	Medium	150°F
	Well Done	160°F
Pork	Medium	150°F
	Well Done	160°F
Poultry	Dark meat	170°F
	Light meat	160°F

Guide for cooking poultry in your microwave

- Place poultry on a microwave-safe roasting rack in a microwave-safe dish.
- Cover poultry with wax paper to prevent spattering.
- Use aluminum foil to shield bone tips, thin meat areas, or areas that start to overcook.
- Check the temperature in several places before letting the poultry stand the recommended time.

FOOD	COOK TIME/POWER LEVEL	DIRECTIONS
Whole chicken Up to 4 lbs.	Cooking Time: 6-9 min. / lb. 180°F dark meat 170°F light meat	Place roast fat-side down on roasting rack. Cover with wax paper. Turn over half way through cooking. Let stand 10 minutes.
	Power Level: Medium High(7).	
Chicken pieces Up to 2 lbs.	Cooking Time: 6-9 min. / lb. 180°F dark meat 170°F light meat	Place roast fat-side down on roasting rack. Cover with wax paper. Turn over half way through cooking. Let stand 10 minutes.
	Power Level: Medium High(7).	

Guide for cooking seafood in your microwave

- Cook fish until it flakes easily with a fork.
- Place fish on a microwave-safe roasting rack in a microwave-safe dish.
- Use a tight cover to steam fish. A lighter cover of wax paper or paper towel provides less steaming.
- Do not overcook fish; check it at minimum cooking time.

FOOD	COOK TIME/POWER LEVEL	DIRECTIONS
Steaks Up to 1.5 lbs.	Cooking Time: 6-10 min. / lb.	Arrange steaks on roasting rack with meaty portions towards the outside of rack. Cover with wax paper. Turn over and rearrange when cooking time is half up. Cook until fish flakes easily with a fork. Let stand 3-5 minutes.
	Power Level: Medium-High(7).	
Filletts Up to 1.5 lbs.	Cooking Time: 3-7 min. / lb	Arrange fillets in a baking dish, turning any thin pieces under. Cover with wax paper. If over ½ inch thick, turn over and rearrange when cooking time is half up. Cook until fish flakes easily with a fork. Let stand 2-3 minutes.
	Power Level: Medium-High(7).	
Shrimp Up to 1.5 lbs.	Cooking Time: 3-5½ min. / lb.	Arrange shrimp in a baking dish without overlapping or layering. Cover with wax paper. Cook until firm and opaque, stirring 2 or 3 times. Let stand 5 minutes.
	Power Level: Medium-High(7).	

Guide for cooking eggs in your microwave

- Never cook eggs in the shell, and never warm hard-cooked eggs in the shell; they can explode.
- Always pierce whole eggs to keep them from bursting.
- Cook eggs just until set; they become tough if overcooked.

Guide for cooking vegetables in your microwave

- Vegetables should be washed just before cooking. Often, no extra water is needed. If dense vegetables such as potatoes, carrots and green beans are being cooked, add about ¼ cup water.
- Small vegetables (sliced carrots, peas, lima beans, etc.) will cook faster than larger ones.
- Whole vegetables, such as potatoes, acorn squash or corn on the cob, should be arranged in a circle on the turntable before cooking. They will cook more evenly if turned over after half the cooking time has passed.
- Always place vegetables like asparagus and broccoli with the stem ends pointing towards the edge of the dish and the tips toward the center.
- When cooking cut vegetables, always cover the dish with a lid or vented microwavable plastic wrap.
- Whole, unpeeled vegetables such as potatoes, squash, eggplant, etc., should have their skin pricked in several spots before cooking to prevent them from bursting.
- For more even cooking, stir or rearrange whole vegetables halfway through the cooking time.
- Generally, the denser the food, the longer the standing time. (Standing time refers to the time necessary for dense, large foods and vegetables to finish cooking after they come out of the oven.) A baked potato can stand on the counter for five minutes before cooking is completed, while a dish of peas can be served immediately.

RECIPES

Beef and barley stew

- 1½ lbs. beef stew cubes, cut into ½-inch pieces
- ½ cup chopped onion
- 2 Tbs. all-purpose flour
- 1 Tbs Worcestershire sauce
- 1 can (13.75-14.5 oz.) beef broth
- 2 medium carrots, cut into ½-inch slices (about 1 cup)
- ½ cup barley
- 1 bay leaf
- ¼ tsp. pepper
- 1 pkg. (9-10 oz.) frozen peas, thawed

1. In a 2-quart casserole, combine beef, onion, flour, and Worcestershire; mix well. Cover with lid. Cook at High for 6 to 8 minutes until beef is no longer pink, stirring once.
2. Stir in beef broth, carrots, barley, bay leaf, and pepper. Cover with lid. Cook at Medium for 1 to 1½ hours until carrots and beef are tender, stirring 2 to 3 times.
3. Stir in peas. Cover with lid. Cook at Medium for 10 minutes. Let stand for 10 minutes. Remove bay leaf before serving.

Makes 6 servings.

Broccoli and cheese casserole

- ¼ cup butter or margarine
- ¼ cup chopped onion
- 1½ Tbs. flour
- ½ tsp. salt
- ¼ tsp. dry mustard
- 1/8 tsp. pepper
- 1½ cups milk
- ¼ cup chopped red pepper
- 8 oz. (2 cups) cheddar cheese, shredded
- 1 pkg. (9-10 oz.) frozen chopped broccoli, thawed
- 4 cups cooked spiral shaped pasta (8 oz. dry)

1. In a 2-quart casserole, cook butter and onion at High for 1 to 2 minutes until onion is soft, stirring once.
2. Add flour, salt, mustard, and pepper; mix well. Cook at High for 30 to 60 seconds until mixture boils. Stir in milk until smooth.
3. Stir in red pepper. Cook at High for 2 to 3 minutes until mixture boils and thickens slightly, stirring twice. Stir in cheese until melted.
4. Add broccoli and pasta, mix well. Cover with lid. Cook at High for 4 to 6 minutes until heated through, stirring once. Stir before serving.

Makes 6 servings.

Warm potato salad

- 2 lbs. small red potatoes, cut into ½-inch pieces
- 4 slices bacon (uncooked), cut into ½-inch pieces
- ¼ cup chopped onion
- 2 tsp. sugar
- 1 tsp. salt
- 1 tsp. flour
- ½ tsp. celery seed
- 1/8 tsp. pepper
- 2½ Tbs. apple cider vinegar

1. In a 2-quart casserole, combine potatoes and ¼ cup water. Cover with lid. Cook at High until potatoes are tender (7-10 minutes); stir twice. Drain and set aside to cool slightly.
2. In a medium bowl, cook bacon at High until crisp (2½-3½ minutes); stir once. Place bacon on a paper towel. Reserve 1 Tbs. drippings.
3. Combine drippings and onion. Cover with plastic wrap; turn back a corner to vent steam. Cook at High until tender (1½-2½ minutes); stir once.
4. Stir in sugar, salt, flour, celery seed, and pepper. Cook at High until mixture boils (30-40 seconds). Stir in vinegar and ½ cup water. Cook at High until liquid boils and thickens slightly (1-2 minutes); stir once. Add bacon to dressing. Pour dressing over potatoes. Stir well.

Makes 6 servings.

Black bean soup

- 1 cup chopped onion
- 1 clove garlic, minced
- 2 cans (15 oz. each) black beans, drained
- 1 can (14-16 oz.) stewed tomatoes, chopped
- 1 can (13.75-14.5 oz.) chicken broth
- 1 can (7-8.5 oz.) corn
- 1 can (4 oz.) chopped green chilies
- 1-2 tsp. ground cumin, or to taste

1. Place onion and garlic in a 3-quart casserole. Cover with lid. Cook at High for 2 to 4 minutes until tender.
2. Add one can of beans, mash beans with a fork. Add remaining ingredients; mix well.
3. Cook uncovered, at High for 10 minutes; stir. Reduce power to Medium and cook for 5 minutes. Stir before serving.

Makes about 2 quarts.

TROUBLESHOOTING

Before you call a repair person for your oven, check this list of possible problems and solutions.

PROBLEM	SOLUTIONS
Neither the oven's display nor the oven operate.	<ul style="list-style-type: none"> • Properly insert the plug into a grounded outlet. • If the outlet is controlled by a wall switch, make sure the wall switch is turned on. • Remove the plug from the outlet, wait ten seconds, then plug it in again. • Reset the circuit breaker or replace any blown fuse. • Plug another appliance into the outlet; if the other appliance doesn't work, have a qualified electrician repair the outlet. • Plug the oven into a different outlet.
The oven's display works, but the power won't come on.	<ul style="list-style-type: none"> • Make sure the door is closed securely. • Check to see if packing material or other material is stuck to the door seal. • Check for door damage. • Press Cancel twice and re-enter all cooking instructions.
The power goes off before the set time has elapsed.	<ul style="list-style-type: none"> • If there has not been a power outage, remove the plug from the outlet, wait ten seconds, then plug it in again. If there was a power outage, the time indicator will display: <i>ENJOY YOUR COOKING - - - PRESS MY CHOICE FOR PERSONAL OPTIONS.</i> • Reset the clock and any cooking instructions. • Reset the circuit breaker or replace any blown fuse.
The food is cooked too slowly.	<ul style="list-style-type: none"> • Make sure the oven is on its own 20 amp circuit line. Operating another appliance on the same circuit can cause a voltage drop. If necessary, move the oven to its own circuit.
You see sparks or arcing.	<ul style="list-style-type: none"> • Remove any metallic utensils, cookware, or metal ties. If using foil, use only narrow strips and allow at least one inch between the foil and interior oven walls.
The turntable makes noises or sticks.	<ul style="list-style-type: none"> • Clean the turntable, roller ring and oven floor. • Make sure the turntable and roller ring are positioned correctly.
Using your microwave causes tv or radio interference.	<ul style="list-style-type: none"> • This is similar to the interference caused by other small appliances, such as hair dryers. Move your microwave further away from other appliances, like your TV or radio.



If the oven is set to cook for more than 25 minutes, it will automatically adjust itself to 70 percent power after 25 minutes to avoid overcooking.

CARE AND CLEANING

- Follow these instructions to clean and care for your oven.
- Keep the inside of the oven clean. Food particles and spilled liquids can stick to the oven walls, causing the oven to work less efficiently.
- Wipe up spills immediately. Use a damp cloth and mild soap. Do not use harsh detergents or abrasives.
- To help loosen baked on food particles or liquids, heat two cups of water (add the juice of one lemon if you desire to keep the oven fresh) in a four-cup measuring glass at High power for five minutes or until boiling. Let stand in the oven for one or two minutes.
- Remove the glass tray from the oven when cleaning the oven or tray. To prevent the tray from breaking, handle it carefully and do not put it in water immediately after cooking. Wash the tray carefully in warm sudsy water or in the dishwasher.
- Clean the outside surface of the oven with soap and a damp cloth. Dry with a soft cloth. To prevent damage to the operating parts of the oven, don't let water seep into the openings.
- Wash the door window with very mild soap and water. Be sure to use a soft cloth to avoid scratching.
- If steam accumulates inside or outside the oven door, wipe with a soft cloth. Steam can accumulate when operating the oven in high humidity and in no way indicates microwave leakage.
- Never operate the oven without food in it; this can damage the magnetron tube or glass tray. You may wish to leave a cup of water in the oven when it is not in use to prevent damage if the oven is accidentally turned on.

How to clean the outside

Do not use cleaners containing ammonia or alcohol on the microwave oven. Ammonia or alcohol can damage the appearance of the microwave.

Case	<ul style="list-style-type: none"> • Clean the outside of the microwave with a sudsy cloth. Rinse and then dry. Wipe the window clean with a damp cloth.
Control panel and door	<ul style="list-style-type: none"> • Wipe with a damp cloth. Dry thoroughly. Do not use cleaning sprays, large amounts of soap and water, abrasives or sharp objects on the panel—they can damage it. Some paper towels can also scratch the control panel.
Door surface	<ul style="list-style-type: none"> • It's important to keep the area clean where the door seals against the microwave. Use only mild, nonabrasive detergents applied with a clean sponge or soft cloth. Rinse well.
Bottom	<ul style="list-style-type: none"> • Clean off the grease and dust on the bottom often. • Use a solution of warm water and detergent.

LIGHT BULB REPLACEMENT

Cooktop light

Replace the burned-out bulb with a 40-watt incandescent bulb.

To replace the bulb(s), first disconnect the power at the main fuse or circuit breaker panel or pull the plug.

1. Remove the screw at the front of the light cover and lower the cover.

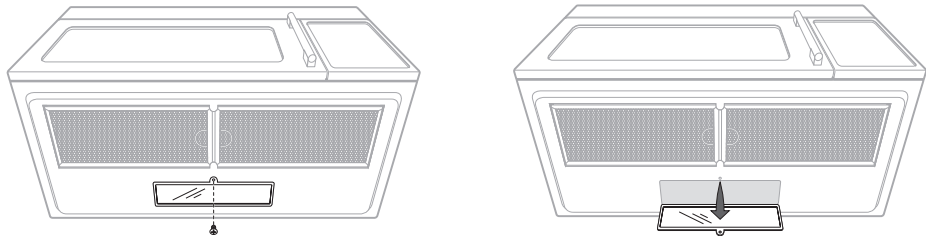

2. Be sure the bulb(s) to be replaced are cool before removing. After breaking the adhesive seal, remove the bulb by gently turning. Put in new bulb.
3. Replace the light cover and screw. Connect electrical power to the oven.

Oven light

Replace the burned-out bulb with a 40-watt incandescent bulb.

To replace the oven light, first disconnect the power at the main fuse or circuit breaker panel or pull the plug.

1. Remove the top grille by taking out the 2 screws that hold it in place. Next, remove the screw located above the door near the center of the oven that secures the light housing. Remove the housing and bulb.
2. Insert new bulb. Replace the light housing and screw.
3. Replace the top grille and 2 screws, Connect electrical power to the oven.

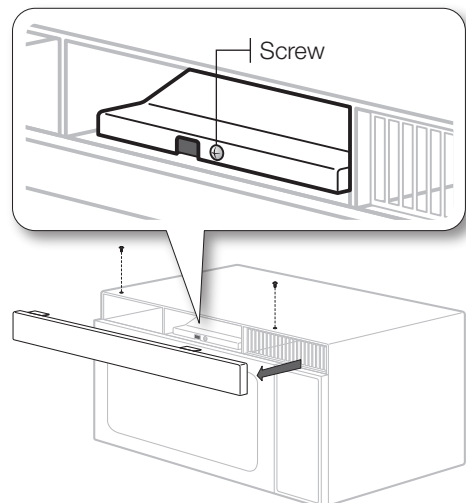

THE VENT FAN

- The exhaust fan has 2 metal reusable grease filter.
- A charcoal filter can be used for removing smoke and odors in case the fan is not vented outside.

Grease filters

The metal filters trap grease released by foods on the cooktop. They also prevent flames from foods on the cooktop from damaging the inside of the microwave.

For this reason, the filters must ALWAYS be in place when the vent fan is used. The grease filters should be cleaned once a month, or as needed.

TO REMOVE, slide it to the left (or right) using the tab. Pull it down and out.

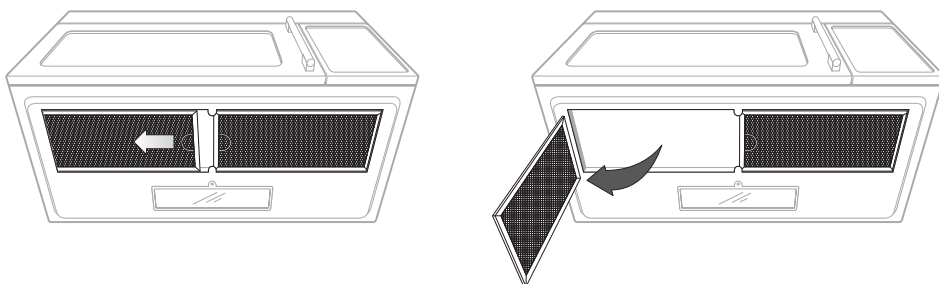

TO CLEAN THE GREASE FILTERS, soak and then swish them around in hot water and detergent.

Don't use ammonia or ammonia products because they will darken the metal.

Light brushing can be used to remove embedded dirt.

Rinse, shake and let them dry before replacing.

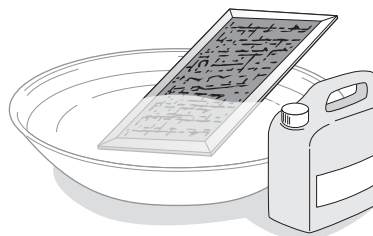

TO REPLACE, slide the filters in the frame slot on the left (or right) of the opening. Pull up and to the right (or left) to lock into place.

Charcoal filter

The charcoal filter cannot be cleaned. It must be replaced.

If the oven is installed on the wall (or cabinet) and not vented to the outside, the air will be recirculated through a disposable charcoal filter that helps remove smoke and odors.

The charcoal filter should be replaced when it is noticeably dirty or discolored (usually after 6 to 12 months, depending on hood usage).

TO REMOVE THE CHARCOAL FILTER, disconnect power at the main fuse or circuit breaker panel or pull the plug.

Remove the top grille by removing the 2 screws that hold it in place. Slide the filter towards the front of the oven and remove it.

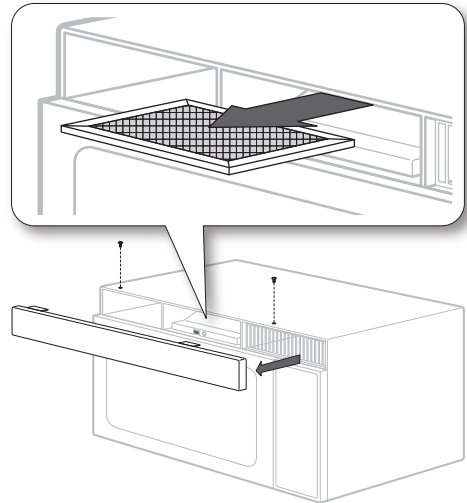

TO INSTALL A NEW FILTER, remove plastic and other outer wrapping from the new filter.

Insert the filter into the top opening of the oven as shown. It will rest at an angle on 2 side support tabs and in front of the right rear tab. Replace the grille and 2 screws.

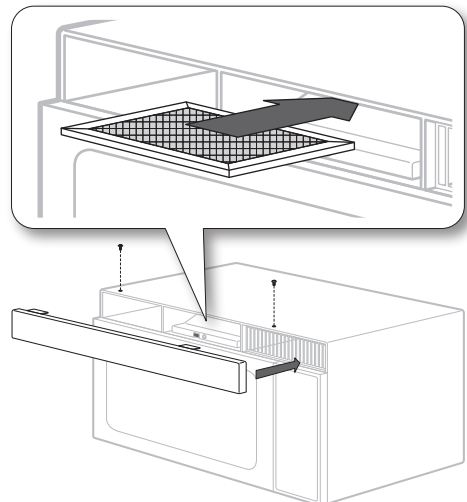

SPECIFICATIONS

MODEL NUMBER	SMH8187BG / SHM8187WG
Oven Cavity	1.8 cuft
Controls	10 power levels, including defrost
Timer	99 minutes, 99 seconds
Power Source	120 VAC, 60 Hz
Power Consumption	1500 Watts
Power Output	1000 Watts
Oven Cavity Dimensions	20 ⁷ / ₈ "(W) X 9 ³¹ / ₃₂ "(H) X 14 ⁹ / ₁₆ "(D)
Outside Dimensions	29 ⁷ / ₈ "(W) X 16 ¹ / ₂ "(H) X 15 ¹⁵ / ₃₂ "(D)
Shipping Dimensions	33 ³ / ₈ "(W) X 19 ¹⁵ / ₁₆ "(H) X 19 ¹³ / ₃₂ "(D)
Net/Gross Weight	50.56/61.12 lbs

MODEL NUMBER	SMH8187STG
Oven Cavity	1.8 cuft
Controls	10 power levels, including defrost
Timer	99 minutes, 99 seconds
Power Source	120 VAC, 60 Hz
Power Consumption	1500 Watts
Power Output	1000 Watts
Oven Cavity Dimensions	20 ⁷ / ₈ "(W) X 9 ³¹ / ₃₂ "(H) X 14 ⁹ / ₁₆ "(D)
Outside Dimensions	29 ⁷ / ₈ "(W) X 16 ¹ / ₂ "(H) X 15 ¹⁵ / ₃₂ "(D)
Shipping Dimensions	33 ³ / ₈ "(W) X 19 ¹⁵ / ₁₆ "(H) X 19 ¹³ / ₃₂ "(D)
Net/Gross Weight	51.6/62.7 lbs

**IF YOU HAVE A PROBLEM YOU CANNOT SOLVE, PLEASE CALL OUR SERVICE LINE:
1-800-SAMSUNG (7267864)**

SAMSUNG OVER-THE-RANGE(OTR) MICROWAVE OVEN

LIMITED WARRANTY TO ORIGINAL PURCHASER

This SAMSUNG brand product, as supplied and distributed by Samsung Electronics Canada, Inc. and delivered new, in the original carton to the original consumer purchaser, is warranted by SAMSUNG against manufacturing defects in materials and workmanship for a limited warranty period of:

ONE (1) YEAR PARTS AND LABOR, TEN (10) YEARS PARTS WARRANTY FOR MAGNETRON

This limited warranty begins on the original date of purchase, and is valid only on products purchased and used in the Canada. To receive warranty service, the purchaser must contact SAMSUNG for problem determination and service procedures. Warranty service can only be performed by a SAMSUNG authorized service center. The original dated bill of sale must be presented upon request as proof of purchase to SAMSUNG or SAMSUNG's authorized service center.

SAMSUNG will repair or replace this product, at our option and at no charge as stipulated herein, with new or reconditioned parts or products if found to be defective during the limited warranty period specified above. All replaced parts and products become the property of SAMSUNG and must be returned to SAMSUNG. Replacement parts and products assume the remaining original warranty, or ninety (90) days, whichever is longer.

In-home service will be provided during the warranty labor period subject to availability within the Canada. In-home service is not available in all areas. To receive in-home service, the product must be unobstructed and accessible to service personnel. If during in-home service repair can not be completed, it may be necessary to remove, repair and return the product. If in-home service is unavailable, SAMSUNG may elect, at our option, to provide for transportation of our choice to and from a SAMSUNG authorized service center. Otherwise, transportation to and from the SAMSUNG authorized service center is the responsibility of the purchaser.

This limited warranty covers manufacturing defects in materials and workmanship encountered in normal, noncommercial use of this product and shall not apply to the following, including, but not limited to: damage which occurs in shipment; delivery and installation; applications and uses for which this product was not intended; altered product or serial numbers; cosmetic damage or exterior finish; accidents, abuse, neglect, fire, water, lightning or other acts of nature; use of products, equipment, systems, utilities, services, parts, supplies, accessories, applications, installations, repairs, external wiring or connectors not supplied or authorized by SAMSUNG which damage this product or result in service problems; incorrect electrical line voltage, fluctuations and surges;

customer adjustments and failure to follow operating instructions, cleaning, maintenance and environmental instructions that are covered and prescribed in the instruction book; problems caused by pest infestations, and overheating or overcooking by user; glass tray or turntable; reduced magnetron power output related to normal aging. SAMSUNG does not warrant uninterrupted or error-free operation of the product.

THERE ARE NO EXPRESS WARRANTIES OTHER THAN THOSE LISTED AND DESCRIBED ABOVE, AND NO WARRANTIES WHETHER EXPRESS OR IMPLIED, INCLUDING, BUT NOT LIMITED TO, ANY IMPLIED WARRANTIES OF MERCHANTABILITY OR FITNESS FOR A PARTICULAR PURPOSE, SHALL APPLY AFTER THE EXPRESS WARRANTY PERIODS STATED ABOVE, AND NO OTHER EXPRESS WARRANTY OR GUARANTY GIVEN BY ANY PERSON, FIRM OR CORPORATION WITH RESPECT TO THIS PRODUCT SHALL BE BINDING ON SAMSUNG. SAMSUNG SHALL NOT BE LIABLE FOR LOSS OF REVENUE OR PROFITS, FAILURE TO REALIZE SAVINGS OR OTHER BENEFITS, OR ANY OTHER SPECIAL, INCIDENTAL OR CONSEQUENTIAL DAMAGES CAUSED BY THE USE, MISUSE OR INABILITY TO USE THIS PRODUCT, REGARDLESS OF THE LEGAL THEORY ON WHICH THE CLAIM IS BASED, AND EVEN IF SAMSUNG HAS BEEN ADVISED OF THE POSSIBILITY OF SUCH DAMAGES. NOR SHALL RECOVERY OF ANY KIND AGAINST SAMSUNG BE GREATER IN AMOUNT THAN THE PURCHASE PRICE OF THE PRODUCT SOLD BY SAMSUNG AND CAUSING THE ALLEGED DAMAGE. WITHOUT LIMITING THE FOREGOING, PURCHASER ASSUMES ALL RISK AND LIABILITY FOR LOSS, DAMAGE OR INJURY TO PURCHASER AND PURCHASER'S PROPERTY AND TO OTHERS AND THEIR PROPERTY ARISING OUT OF THE USE, MISUSE OR INABILITY TO USE THIS PRODUCT SOLD BY SAMSUNG NOT CAUSED DIRECTLY BY THE NEGLIGENCE OF SAMSUNG. THIS LIMITED WARRANTY SHALL NOT EXTEND TO ANYONE OTHER THAN THE ORIGINAL PURCHASER OF THIS PRODUCT, IS NONTRANSFERABLE AND STATES YOUR EXCLUSIVE REMEDY.

Some province do not allow limitations on how long an implied warranty lasts, or the exclusion or limitation of incidental or consequential damages, so the above limitations or exclusions may not apply to you. This warranty gives you specific legal rights, and you may also have other rights which vary from state to state.

To obtain warranty service, please contact SAMSUNG at:

1-800-SAMSUNG (7267864) and www.samsung.com/ca



QUESTIONS OR COMMENTS?

COUNTRY	CALL	OR VISIT US ONLINE AT
IN CANADA	1-800-SAMSUNG (7267864)	www.samsung.com/ca

DE68-00356Y